



desk-add



VERSION 01 | 2013

Inhaltsverzeichnis	Kapitel	Contents	Chapter
Oberflächen - Farben	01.01 - 01.04	surfaces - colours	01.01 - 01.04
Rollcontainer	02.01 - 02.03	mobile pedestal	02.01 - 02.03
Typ 1, Blenden mit Griff		type 1, blinds with handles	
Typ 2, grifflose Blenden		type 2, blinds without handles	
Zubehör		accessories	
Anstellcontainer	03.01 - 03.02	desk height pedestal	03.01 - 03.02
Typ 1, Blenden mit Griff		type 1, with handles	
Technikcontainer	04.01 - 04.02	pedestal for files and hardware	04.01 - 04.02
95 cm breit		95 cm wide	
120 cm breit		120 cm wide	
Caddy mit Vertikalrolläden	05.01 - 05.02	caddy with vertical roller blind	05.01 - 05.02
Caddy mit Horizontalrolläden	06.01	caddy with horizontal roller blind	06.01
Caddy mit grifflosen Blenden	07.01	caddy, blinds without handles	07.01
Apothekerschrank	08.01 - 08.03	pull-out cupboard unit	08.01 - 08.03
Erläuterungen		explanations	
72 cm hoch		72 cm high	
120 cm hoch		120 cm high	

Auflage 01
 unverbindliche Preisempfehlung
 alle Preise in EURO, zzgl. gesetzl. MwSt.,
 gültig ab 01. August 2013
 geringe Konstruktionsänderungen vorbehalten
 alle Maßangaben in Zentimeter

Zertifizierungen

Das Unternehmen ist nach DIN EN ISO 9001:2008
 zertifiziert.

Firmenanschrift

LEUWICO GmbH
 Hauptstraße 2 - 4, 96484 Wiesenfeld, Deutschland
 Telefon: +49 (0) 9566 88 0
 Telefax: +49 (0) 9566 88 114
 E-Mail: info@leuwico.com
 www.leuwico.com

Edition 01
 recommended retail price
 without VAT, prices in EURO,
 valid from August 1st, 2013
 slight constructional alterations subject to change
 all dimensions are indicated in cm

Certificates

the company is certified according to
 DIN EN ISO 9001:2008

Company address

LEUWICO GmbH
 Hauptstraße 2 - 4, 96484 Wiesenfeld, Germany
 Phone: +49 (0) 9566 88 0
 Fax: +49 (0) 9566 88 114
 Email: info@leuwico.com
 www.leuwico.com

Artikelbezeichnung und Farbkennung

Zur eindeutigen Bestimmung eines Artikels ist die Angabe

- der Artikelbezeichnung und
- der Farbkennung erforderlich.

In Artikelbezeichnungen, die Varianten enthalten, müssen eine oder mehrere Angaben, z. B. zu Korpus oder Blenden, eingesetzt werden.

Die einzusetzenden Zeichen entsprechen der Anzahl der Sternchen (*).

Optionen werden durch Ergänzungen zur Artikelbezeichnung gekennzeichnet. Zum Teil muss für die Optionen ein Aufpreis addiert werden.

Die Anzahl der notwendigen Farbangaben variiert von Artikel zu Artikel. Die Reihenfolge ist durch Nummerierung definiert.

DARC1-1233- SM- 072 / 026
Variante: Oberfläche Blenden: Melamin
Notwendige Farbangaben: 1. Korpus: graphit 2. Oberfläche Blenden: Ahorn Dekor

Article reference and colour code

For the exact article definition the following details are required:

- the article reference and
- the colour code

Articles which are available in different variants have to be completed with one or more details such as the carcass or the blinds. The number of stars (*) shows the number of symbols which have to be indicated.

Options will be added to the article reference and the up-charge for some options has to be added to the basic article price.

The number of required colour codes is different for each article. The sequence is defined by the numbering.

DARC1-1233- SM- 072 / 026
variant: surface blinds: melamine
necessary colour detail: 1. carcass: graphite 2. surface blinds: maple decor

Übersicht der Artikel mit notwendigen Farbangaben für die Bestellung - siehe 01.02 bis 01.04

Overview of article with necessary colour details for orders - see 01.02 - 01.04:

Diese Artikel haben immer folgende Farbausführung:

These articles are available only with the following colours:

Artikel	article	Farbe / colour
Container	pedestal	
- Inneneinrichtung	-partitions	- schwarz / black
Caddy	caddy	
- Griffeinsatz (bei DACV2, DACH2)	- integrated handle (with DACV2, DACH2)	- alu optic / alu optic
- Griff (bei DACV3, DACS1)	- handle (with DACV3, DACS1)	- Edelstahl / stainless steel
- Breitschub, Auszug f. A4-Hänge-	-organisation drawer, A4 filing frame,	- schwarz / black
mappen, MaterialdrehSchale	swivelling pencil tray	
Apothekerschrank	pull-out cupboard unit	
- Steckerleiste (Option)	-plug panel (option)	- schwarz / black
- Griff	- handle	- Edelstahl / stainless steel

Farbkürzel / colour codes

011	lichtgrau	light grey	070	orangerot	orange red
021	schwarz struktur	black structure	071	apfelgrün	apple green
022	silber struktur	silver structure	072	graphit	graphite
023	lichtgrau struktur	light grey structure	080	Pflaume Dekor	plum decor
024	Buche Dekor	beech decor	081	Kirschaum Dekor	cherry tree decor
026	Ahorn Dekor	maple decor	082	Olive dunkel Dekor	olive wood decor
029	silber metallic	silver metallic	111	Echtholz Buche	beech veneer
030	alu optic	alu optic	122	Echtholz Esche schwarz offenporig	ash tree open-pored veneer
041	weißaluminium	aluminium white	131	Echtholz Ahorn europäisch	European maple veneer
042	Weißbuche Dekor	light beech decor	132	Echtholz Ahorn kanadisch	Canadian maple veneer
044	alugrau	aluminium grey	141	Echtholz Schweizer Birnbaum	Swiss pearwood veneer
049	kristallweiß	crystal white	161	Echtholz Nussbaum	walnut veneer
051	Balearen Eiche Dekor	Balearic oak decor	171	Echtholz Zebrano	zebrano veneer
052	Zebrano Dekor	zebrano decor	181	Echtholz Eiche	oak veneer
055	kristallweiß struktur	crystal white structure	191	Echtholz Kirschbaum	cherry veneer
068	graphit struktur	graphite structure			

Übersicht der Griffe (Option für Blenden und Rollläden) / survey of handles (option for blinds and roller blinds)

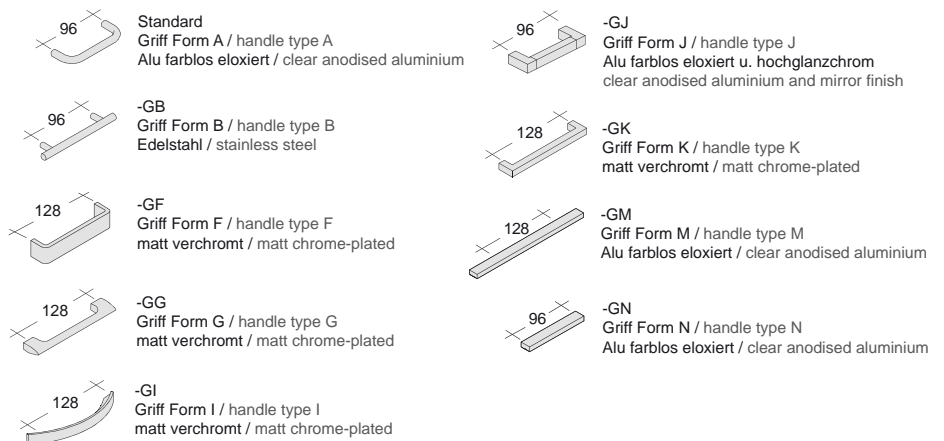









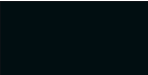

Wichtiger Hinweis:

Holz ist ein gewachsener Werkstoff. Kein Stamm gleicht dem anderen. Die einzelnen Stämme unterscheiden sich in Maserung und Farbe. Aber auch innerhalb eines Stammes treten Struktur- und Tonunterschiede auf. Unter Lichteinwirkung und durch extrem feuchtes oder extrem trockenes Klima kann sich die Holzfarbe ändern. **Unterschiede, Unregelmäßigkeiten und Veränderungen, die aufgrund der natürlichen Beschaffenheit des Holzes auftreten, sind kein Grund zur Beanstandung.** Die Furniere werden sorgfältig und kommissionsweise ausgewählt. Soweit möglich verwenden wir für einen Auftrag Furnier aus einem Stamm. Dadurch werden die Unterschiede in Struktur und Färbung so gering wie möglich gehalten. Bei Nachlieferungen sind Unterschiede in Struktur und Färbung kein Grund zur Beanstandung.

Important note:

Wood is a grown material. No trunk of a tree is alike the other. The single trunks are different in grain and colour. Also within a trunk there are differences in structure and tone. When exposed to light radiation and in an extremely humid or extremely dry climate the wood colour can change. **Differences and changes caused by the natural quality of the wood are no reason for complaint.** The veneer will be chosen carefully and separately for each commission. As far as possible we use veneer of the same trunk for one order. This helps to keep differences in structure and colour as low as possible. Differences in structure and colour are no reason for complaint in subsequent deliveries.

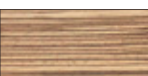
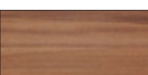





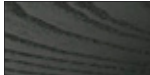

Melamin / Melamine surface

	011 lichtgrau light grey
	014 schwarz black
	041 weißaluminium aluminium white
	049 kristallweiß crystal white
	072 graphit graphite
	024 Buche Dekor beech decor
	026 Ahorn Dekor maple decor
	042 Weißbuche Dekor light beech decor
	051 Balearen Eiche Dekor Balearic oak decor
	052 Zebrano Dekor zebrano decor
	080 Pflaume Dekor plum decor
	081 Kirschbaum Dekor cherry tree decor
	082 Olive dunkel Dekor olive wood decor

**Kabeldurchlass aus Kunststoff
Cable outlet made of plastic**

	014 schwarz black
	044 alugrau aluminium grey
	049 kristallweiß crystal white

Furnier Echtholz / Veneer surface real wood

	111 Echtholz Buche beech veneer
	122 Echtholz Esche schwarz offenporig ash tree open-pored veneer
	131 Echtholz Ahorn europäisch European maple veneer
	132 Echtholz Ahorn kanadisch Canadian maple veneer
	141 Echtholz Schweizer Birnbaum Swiss pearwood veneer
	161 Echtholz Nussbaum walnut veneer
	171 Echtholz Zebrano zebrano veneer
	181 Echtholz Eiche oak veneer
	191 Echtholz Kirschbaum cherry veneer

Lack / Lacquer

	070 orangerot orange red
	071 apfelgrün apple green

Metallteile* / Parts made of metal*

	021 schwarz struktur black structure
	022 silber struktur silver structure
	023 lichtgrau struktur light grey structure
	029 silber metallic silver metallic
	055 kristallweiß struktur crystal white structure
	068 graphit struktur graphite structure

02 Rollcontainer / Mobile pedestal

02.01 Rollcontainer Typ 1, Blenden mit Griff / Mobile pedestal type 1, blinds with handles

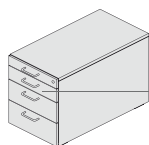

Blenden / blinds	
Melamin / melamine surface	011, 014, 024, 026, 041, 042, 049, 051, 052, 072, 080, 081, 082
Furnier Echtholz / veneer surface real wood	111, 122, 131, 132, 141, 161, 171, 181, 191
Compactplatte / Solid core laminate	041, 049 (Kante schwarz / edge black)

Korpus / carcass	
Melamin / melamine surface	011, 014, 024, 026, 041, 042, 049, 051, 052, 072, 080, 081, 082

02.02 Rollcontainer Typ 2, grifflose Blenden / Mobile pedestal type 2, blinds without handles

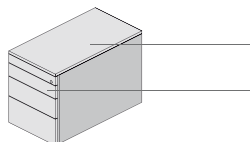

Abdeckplatte und Blenden / top and blinds	
Melamin / melamine surface	011, 014, 024, 026, 041, 042, 049, 051, 052, 072, 080, 081, 082
Furnier Echtholz / veneer surface real wood	111, 122, 131, 132, 141, 161, 171, 181, 191
Lack / lacquer	070, 071 (-FO1)

Korpus / carcass	
Melamin / melamine surface	011, 014, 024, 026, 041, 042, 049, 051, 052, 072, 080, 081, 082

03 Anstellcontainer / Desk height pedestal

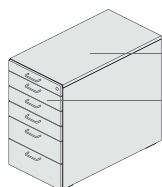

Abdeckplatte, Blenden / top, blinds	
Melamin / melamine surface	011, 014, 024, 026, 041, 042, 049, 051, 052, 072, 080, 081, 082
Furnier Echtholz / veneer surface real wood	111, 122, 131, 132, 141, 161, 171, 181, 191
Compactplatte / Solid core laminate	041, 049 (Kante schwarz, Abdeckplatte: Spanplatte / edge black, cover plate: chipboard)

Korpus / carcass	
Melamin / melamine surface	011, 014, 024, 026, 041, 042, 049, 051, 052, 072, 080, 081, 082

04 Technikcontainer / Pedestal for files and hardware

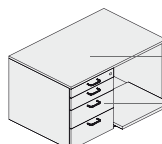

Korpus / carcass	
Melamin / melamine surface	011, 014, 024, 026, 041, 042, 049, 051, 052, 072, 080, 081, 082

Abdeckplatte und Blenden / top and blinds	
Melamin / melamine surface	011, 014, 024, 026, 041, 042, 049, 051, 052, 072, 080, 081, 082
Furnier Echtholz / veneer surface real wood	111, 122, 131, 132, 141, 161, 171, 181, 191
Lack / lacquer	070, 071 (-FO1)

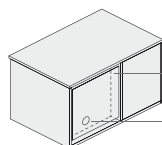

Rückwand (Metall)* / back panel (made of metal)*	
021, 022, 023, 029, 055, 068	

Kabeldurchlass aus Kunststoff / cable outlet made of plastic	
014, 044, 049	

05 Caddy mit Vertikalrollladen / Caddy with vertical roller blind

05.01 Caddy mit Vertikalrollladen, 43 cm breit / Caddy with vertical roller blind, 43 cm wide

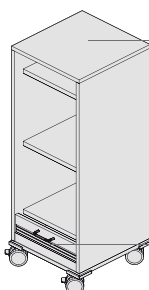

Abdeckplatte / top	
Melamin / melamine surface:	011, 014, 024, 026, 041, 042, 049, 051, 052, 072, 080, 081, 082
Furnier Echtholz / veneer surface real wood	111, 122, 131, 132, 141, 161, 171, 181, 191

Korpus / carcass	
Melamin / melamine surface	011, 014, 024, 026, 041, 042, 049, 051, 052, 072, 080, 081, 082

Rollladen / roller blind	
030	

05.02 Caddy mit Vertikalrollladen, 60 cm breit / Caddy with vertical roller blind, 60 cm wide

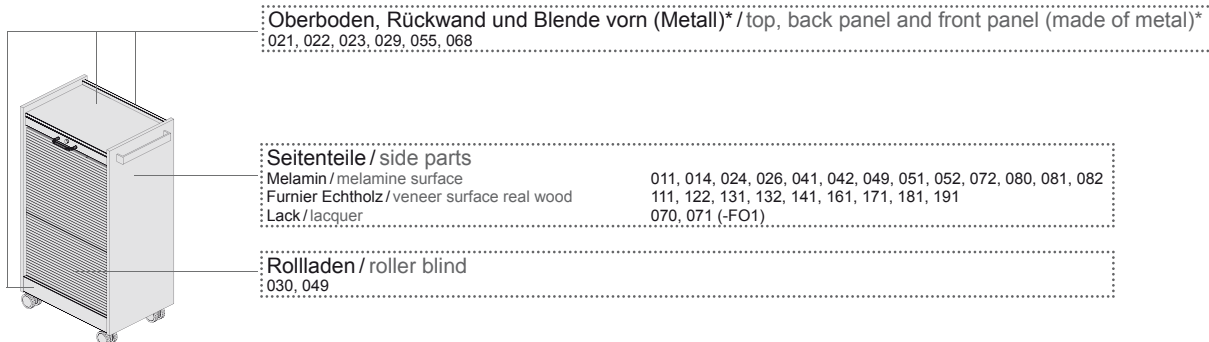

Oberboden, Rückwand und Blende vorn (Metall)* / top, back panel and front panel (made of metal)*
021, 022, 023, 029, 055, 068

Seitenteile / side parts
Melamin / melamine surface 011, 014, 024, 026, 041, 042, 049, 051, 052, 072, 080, 081, 082
Furnier Echtholz / veneer surface real wood 111, 122, 131, 132, 141, 161, 171, 181, 191
Lack / lacquer 070, 071 (-FO1)

Rollladen / roller blind
030, 049

06 Caddy mit Horizontalrollladen, 80 cm breit / Caddy with horizontal roller blind, 80 cm wide

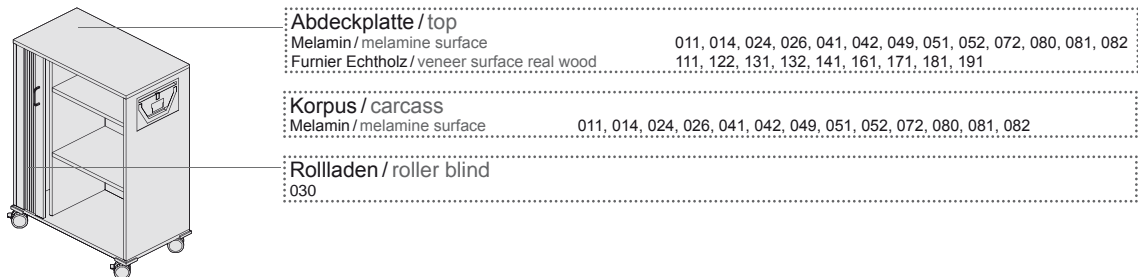

Abdeckplatte / top
Melamin / melamine surface 011, 014, 024, 026, 041, 042, 049, 051, 052, 072, 080, 081, 082
Furnier Echtholz / veneer surface real wood 111, 122, 131, 132, 141, 161, 171, 181, 191

Korpus / carcass
Melamin / melamine surface 011, 014, 024, 026, 041, 042, 049, 051, 052, 072, 080, 081, 082

Rollladen / roller blind
030

07 Caddy mit grifflosen Blenden, 43,5 cm breit / Caddy, blinds without handles, 43,5 cm wide



Abdeckplatte und Blenden / top and blinds
Melamin / melamine surface 011, 014, 024, 026, 041, 042, 049, 051, 052, 072, 080, 081, 082
Furnier Echtholz / veneer surface real wood 111, 122, 131, 132, 141, 161, 171, 181, 191
Lack / lacquer 070, 071 (-FO1)

Korpus / carcass
Melamin / melamine surface 011, 014, 024, 026, 041, 042, 049, 051, 052, 072, 080, 081, 082

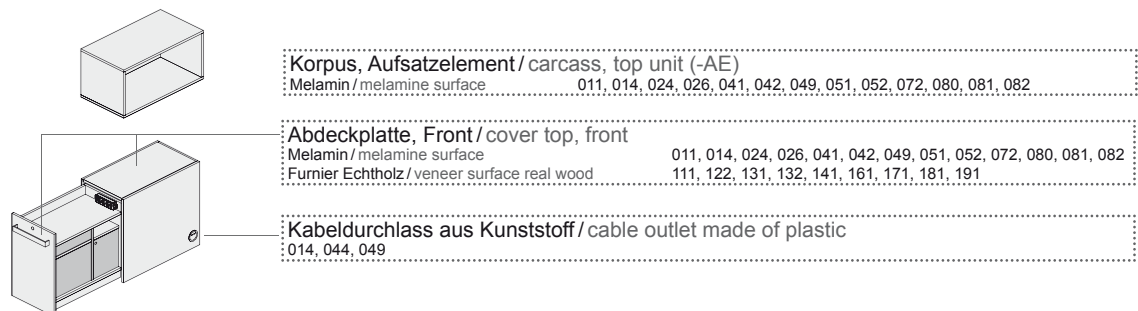

08 Apothekerschränke / Pull-out cupboard units



Korpus, Aufsatzelement / carcass, top unit (-AE)
Melamin / melamine surface 011, 014, 024, 026, 041, 042, 049, 051, 052, 072, 080, 081, 082

Abdeckplatte, Front / cover top, front
Melamin / melamine surface 011, 014, 024, 026, 041, 042, 049, 051, 052, 072, 080, 081, 082
Furnier Echtholz / veneer surface real wood 111, 122, 131, 132, 141, 161, 171, 181, 191

Kabeldurchlass aus Kunststoff / cable outlet made of plastic
014, 044, 049

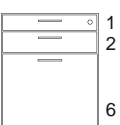
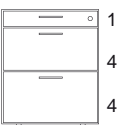
Rollcontainer Typ 1, Blenden mit Griff		mobile pedestal type 1, blinds with handle						
inkl. Griff -GA incl. handle -GA	Trägermaterial Blenden: Oberfläche: basic material for blinds: surface:	Spanplatte Melamin chipboard melamine	Spanplatte Echtholz chipboard real wood	Compactplatte Melamin sci melamine	Griffe handles	Tiefe 60 cm depth 60 cm	Einschub- dämpfung damped closing	
		SM	SF	CM				
 1 2 3 3	DARC1-1233- **				-GB -GF -GG -GI -GJ -GK -GM -GN		-ESD	
 1 2 2 4	DARC1-1224- **				-GB -GF -GG -GI -GJ -GK -GM -GN		-ESD	
 1 2 2 2 2	DARC1-1222- **				-GB -GF -GG -GI -GJ -GK -GM -GN		-ESD	
 1 2 6	DARC1-126- **				-GB -GF -GG -GI -GJ -GK -GM -GN		-ESD	
 1 4 4	DARC1-144- **				-GB -GF -GG -GI -GJ -GK -GM -GN		-ESD	
Notwendige Farbangaben: Necessary colour details:	1. Korpus / carcass	2. Blenden / blinds						

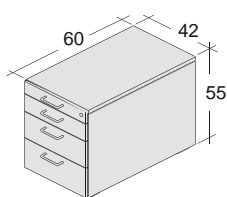
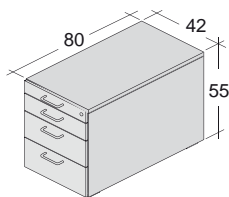

- mit Stahl Schubern in schwarz
- mit harten Rollen (50 mm)
- Fach 1 generell mit Einschubdämpfung, für alle anderen Fächer optional
- Fach 1 voll ausziehbar
- Fächer 2, 3, 4 Teilauszug, Belastbarkeit und Kippsicherheit bis 25 kg
- Fach 6 Vollauszug (Überauszug), Belastbarkeit bis 45 kg, Kippsicherheit bis 36 kg
- Schubfächer immer verschließbar
- Inneneinteilung siehe 02.03
- Griffübersicht siehe 01.01

- with steel drawers in black
- with hard castors (50 mm)
- drawer 1 always with damped closing, for all other drawers damped closing optional
- drawer 1 with 100% opening
- drawers 2, 3, 4 with partial opening, load bearing capacity and tilting prevention up to 25 kg
- drawer 6 with >100% opening, load bearing capacity up to 45 kg, tilting prevention up to 36 kg
- drawers always lockable
- accessories see 02.03
- types of handles see 01.01

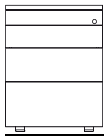
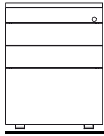
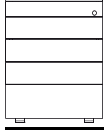
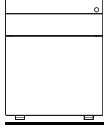
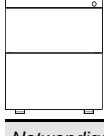
Rollcontainer Typ 2, grifflose Blenden		mobile pedestal type 2, blinds without handle				
Trägermaterial Abdeckplatte und Blenden: Oberfläche: basic material for top and blinds: surface:		Spanplatte Melamin chipboard melamine	Spanplatte Echtholz chipboard real wood	Compactplatte Melamin scl melamine		Für -SM: Abdeckpl./Blenden in 070, 071 For -SM: top/blinds in 070, 071
		SM	SF	CM		
	DARC2-1233- **					-FO1
	DARC2-1224- **					-FO1
	DARC2-1222- **					-FO1
	DARC2-126- **					-FO1
	DARC2-144- **					-FO1
Notwendige Farbangaben: Necessary colour details:	1. Korpus / carcass	2. Abdeckplatte und Blenden / top and blinds				2. Abdeckplatte und Blenden top and blinds

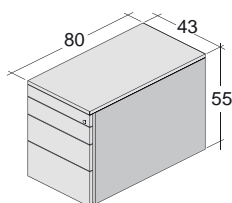

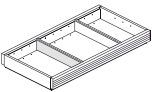
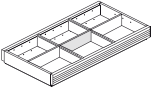
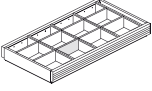
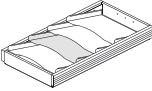

- mit Stahlschüben in schwarz
- mit harten Rollen (50 mm)
- alle Fächer mit Einschubdämpfung
- Fach 1 voll ausziehbar
- alle anderen Fächer mit Vollauszug (Überauszug), Belastbarkeit bis 45 kg, Kippsicherheit bis 36 kg
- Schubfächer immer verschließbar
- Inneneinteilung siehe 02.03
- with steel drawers in black
- with hard castors (50 mm)
- all drawers with damped closing
- drawer 1 with 100% opening
- all other drawers with >100% opening, load bearing capacity up to 45 kg, tilting prevention up to 36 kg
- drawers always lockable
- accessories see 02.03

Inneneinteilung	partitions
 1 Stück Trennschiede A4 / 1 piece of partitions A4	DAC-TR4
 1 Stück Trennschiede A5 / 1 piece of partitions A5	DAC-TR5
 1 Stück Trennschiede A6 / 1 piece of partitions A6	DAC-TR6
 1 Stück Schrägablage / 1 piece of stationary storage	DAC-SAB
<p>für Container Typ 1 - Fächer 2, 3, 4: Teleskopvollauszug (belastbar - 45 kg, Kippsicherheit - 36 kg) pro Fach DAC-TVA for mobile pedestal type 1 - drawers 2, 3 and 4: mechanism for >100% opening (load bearing cap. up to 45 kg, tilting prevention up to 36 kg) each drawer</p> <p>1x Gegengewicht pro Container nicht vergessen! / Do not forget the tilting prevention for one pedestal! Bitte Containertiefe (80 oder 60 cm) angeben! / Please indicate the depth of the pedestal (80 or 60 cm).</p>	
<p>Gegengewicht (Kippsicherung) für Container mit Teleskopvollauszug (DAC-TVA) tilting prevention for pedestals with drawer mechanism >100% opening (DAC-TVA)</p>	DAC-KIS
<p>Bausatz Hängekorb Fach 6 Schweizer Norm / 1 construction set for filing frame Swiss standard (drawer 6)</p>	DAC-HKCH

Schrägablagen pro Containerfach
stationary storage per drawer

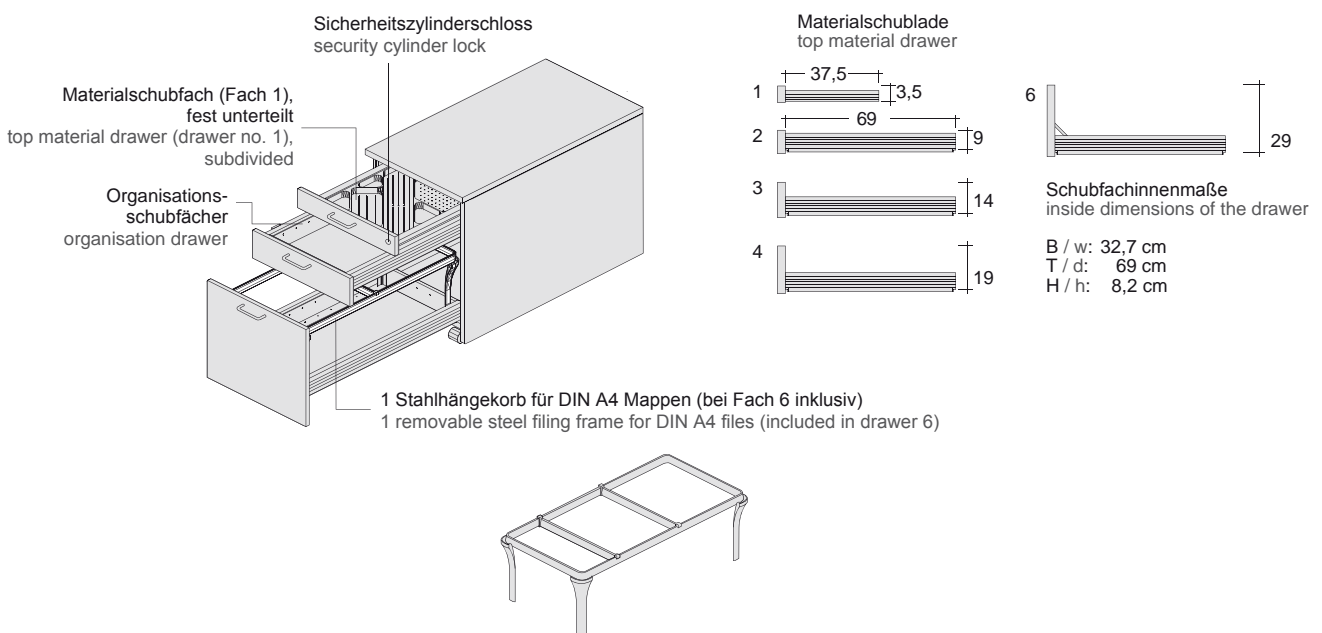
Fach / drawer	3er	4er	6er
80 cm tief / depth	9x	12x	15x

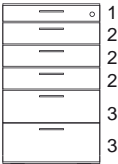
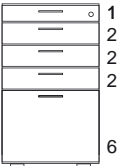

Anstellcontainer		desk height pedestal						
inkl. Griff -GA incl. handle -GA	Trägermaterial Blenden: Oberfläche: basic material for top, blinds: surface:	Spanplatte Melamin chipboard melamine	Spanplatte Echtholz chipboard real wood	Compactplatte Melamin scl melamine	Griffe handles	Einschub- dämpfung damped closing		
		SM	SF	CM				
	DAAC1-122233- **				-GB -GF -GG -GI -GJ -GK -GM -GN	-ESD		
	DAAC1-12226- **				-GB -GF -GG -GI -GJ -GK -GM -GN	-ESD		
	DAAC1-1222222- **				-GB -GF -GG -GI -GJ -GK -GM -GN	-ESD		
Notwendige Farbangaben: Necessary colour details:	1. Korpus / carcass	2. Abdeckplatte (Spanplatte) / top (chipboard)		3. Blenden / blinds				

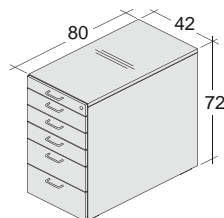

- mit Stahlschüben in schwarz
- Fach 1 generell mit Einschubdämpfung, für alle anderen Fächer optional
- Fach 1 voll ausziehbar
- Fächer 2, 3, 4 Teilauszug, Belastbarkeit und Kippsicherheit bis 25 kg
- Fach 6 Vollauszug (Überauszug), Belastbarkeit bis 45 kg, Kippsicherheit bis 36 kg
- Abdeckplatte immer Spanplatte
- Schubfächer immer verschließbar
- Inneneinteilung siehe 02.03
- Griffübersicht siehe 01.01

- with steel drawers in black
- drawer 1 always with damped closing, for all other drawers damped closing optional
- drawer 1 with 100% opening
- drawers 2, 3, 4 with partial opening, load bearing capacity and tilting prevention up to 25 kg
- drawer 6 with >100% opening, load bearing capacity up to 45 kg, tilting prevention up to 36 kg
- cover plate always chipboard
- drawers always lockable
- accessories see 02.03
- types of handles see 01.01

Weitere Option			further option
Option	Beschreibung	description	
-F90	Furnierrichtung 90° gedreht (nur für Abdeckplatte)	grain of veneer turned by 90 degs (only for top)	---
-75	Höhe Anstellcontainer, 75 cm	desk height pedestal, 75 cm height	---



Furnierrichtung
gedreht

grain of veneer turned
by 90 degs

Leuwico

unverbindliche Preisempfehlungen

alle Preise in EURO, zzgl. gesetzl. MwSt. - 01.08.2013

recommended retail price without VAT, prices in EURO - 01.08.2013

v01

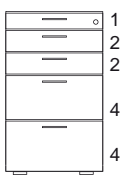
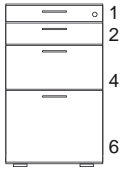
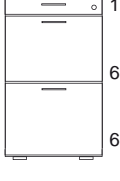
Anstellcontainer		desk height pedestal					
inkl. Griff -GA incl. handle -GA	Trägermaterial Blenden: Oberfläche: basic material for top, blinds: surface:	Spanplatte Melamin chipboard melamine	Spanplatte Echtholz chipboard real wood	Compactplatte Melamin scl melamine	Griffe handles	Einschub- dämpfung damped closing	
		SM	SF	CM			
	DAAC1-12244- **				-GB -GF -GG -GI -GJ -GK -GM -GN	-ESD	
	DAAC1-1246- **				-GB -GF -GG -GI -GJ -GK -GM -GN	-ESD	
	DAAC1-166- **				-GB -GF -GG -GI -GJ -GK -GM -GN	-ESD	
Notwendige Farbangaben: Necessary colour details:		1. Korpus / carcass		2. Abdeckplatte (Spanplatte) / top (chipboard)		3. Blenden / blinds	

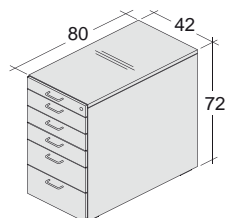

- mit Stahl Schublen in schwarz
- Fach 1 generell mit Einschubdämpfung, für alle anderen Fächer optional
- Fach 1 voll ausziehbar
- Fächer 2, 3, 4 Teilauszug, Belastbarkeit und Kippsicherheit bis 25 kg
- Fach 6 Vollauszug (Überauszug), Belastbarkeit bis 45 kg, Kippsicherheit bis 36 kg
- Abdeckplatte immer Spanplatte
- Schubfächer immer verschließbar
- Inneneinteilung siehe 02.03
- Griffübersicht siehe 01.01

- with steel drawers in black
- drawer 1 always with damped closing, for all other drawers damped closing optional
- drawer 1 with 100% opening
- drawers 2, 3, 4 with partial opening, load bearing capacity and tilting prevention up to 25 kg
- drawer 6 with >100% opening, load bearing capacity up to 45 kg, tilting prevention up to 36 kg
- cover plate always chipboard
- drawers always lockable
- accessories see 02.03
- types of handles see 01.01

Weitere Option			further option
Option	Beschreibung	description	
-F90	Furnierrichtung 90° gedreht (nur für Abdeckplatte)	grain of veneer turned by 90 degs (only for top)	---
-75	Höhe Anstellcontainer, 75 cm	desk height pedestal, 75 cm height	---

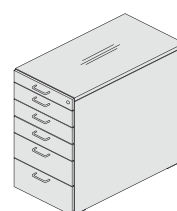

Furnierrichtung
gedreht

grain of veneer turned
by 90 degs

Technikcontainer, 95 cm breit		pedestal for files and hardware, 95 cm wide								
inkl. Griff -GA incl. handle -GA		Abdeckplatte und Blenden: top and blinds:		Melamin melamine	Echtholz real wood veneer	Für -SM: Abdeckpl./Blenden in 070, 071 For -SM: top/blinds in 070, 071		Griffe handles		
				SM	SF					
L		1 2 3 3	DATC09L-1233- **			-FO1		-GB -GF -GG -GI -GJ -GK -GM -GN		
R		1 2 3 3	DATC09R-1233- **			-FO1		-GB -GF -GG -GI -GJ -GK -GM -GN		
L		1 2 6	DATC09L-126- **			-FO1		-GB -GF -GG -GI -GJ -GK -GM -GN		
R		1 2 6	DATC09R-126- **			-FO1		-GB -GF -GG -GI -GJ -GK -GM -GN		
Notwendige Farbangaben: Necessary colour details:		1. Korpus / carcass		3. Abdeckplatte u. Blenden top and blinds		3. Abdeckplatte und Blenden top and blinds				
		2. Rückwand back panel		4. Kabeldurchlass cable outlet						

Technikcontainer, Ausführung rechts
pedestal for files and hardware, right version

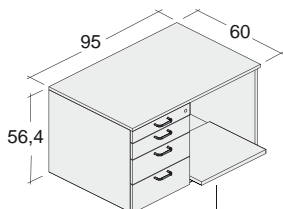

Auszugboden
Druckerfach
lichte Maße (B/T/H): 50/48/43 cm
extraction shelf
printer compartment
inner dimensions (w/d/h): 50/48/43 cm

Rückansicht
rear view

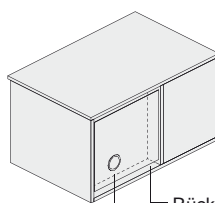

Rückwand aus Metall, abnehmbar
removable metal back panel
Kabeldurchlass
cable outlet

- alle Fächer mit Einschubdämpfung
- Fach 1 voll ausziehbar
- alle anderen Fächer mit Vollauszug (Überauszug), Belastbarkeit bis 45 kg, Kipp-sicherheit bis 36 kg
- Auszugboden bis 20 kg belastbar
- Schubfächer immer verschließbar
- Inneneinteilung siehe 02.03
- Griffübersicht siehe 01.01

- all drawers with damped closing
- drawer 1 with 100% opening
- all other drawers with >100% opening, load bearing capacity up to 45 kg, tilting prevention up to 36 kg
- extraction shelf, load bearing capacity up to 20 kg
- drawers always lockable
- accessories see 02.03
- types of handles see 01.01

Technikcontainer, 120 cm breit		pedestal for files and hardware, 120 cm wide					
inkl. Griff -GA incl. handle -GA		Abdeckplatte und Blenden: top and blinds:	Melamin melamine	Echtholz real wood veneer	Für -SM: Abdeckpl./Blenden in 070, 071 For -SM: top/blinds in 070, 071	Griffe handles	CPU-Fach verschießbar CPU drawer lockable
			SM	SF			
L 		DATC12L-1233- **			-FO1	-GB -GF -GG -GI -GJ -GK -GM* -GN	-VS
R 		DATC12R-1233- **			-FO1	-GB -GF -GG -GI -GJ -GK -GM* -GN	-VS
L 		DATC12L-126- **			-FO1	-GB -GF -GG -GI -GJ -GK -GM* -GN	-VS
R 		DATC12R-126- **			-FO1	-GB -GF -GG -GI -GJ -GK -GM* -GN	-VS
Notwendige Farbangaben: Necessary colour details:		1. Korpus / carcass	3. Abdeckplatte u. Blenden top and blinds		3. Abdeckplatte und Blenden top and blinds		
		2. Rückwand back panel	4. Kabeldurchlass cable outlet				

Technikcontainer, Ausführung rechts
pedestal for files and hardware, right version

Rückansicht
rear view

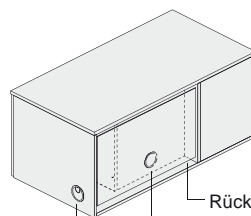
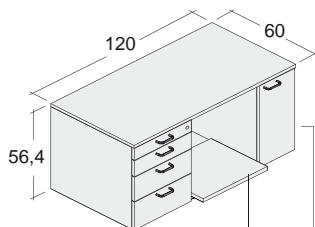

Auszugboden
Druckerfach
lichte Maße (B/T/H): 50/48/43 cm
extraction shelf
printer compartment
inner dimensions (w/d/h): 50/48/43 cm

CPU-Fach
lichte Maße (B/T/H): 23/58/48 cm
CPU drawer
inner dimensions (w/d/h): 23/58/48 cm

Rückwand aus Metall, abnehmbar
removable metal back panel

Kabeldurchlass
cable outlet

- alle Fächer mit Einschubdämpfung
- Fach 1 voll ausziehbar
- alle anderen Fächer mit Vollauszug (Überauszug), Belastbarkeit bis 45 kg, Kippsicherheit bis 36 kg
- Auszugboden bis 20 kg belastbar
- Schubfächer immer verschließbar
- Inneneinteilung siehe 02.03
- Griffübersicht siehe 01.01

- all drawers with damped closing
- drawer 1 with 100% opening
- all other drawers with >100% opening, load bearing capacity up to 45 kg, tilting prevention up to 36 kg
- extraction shelf, load bearing capacity up to 20 kg
- drawers always lockable
- accessories see 02.03
- types of handles see 01.01

* Blenden mit Griff -GM, CPU-Fach mit Griff -GN /blinds with handle -GM, CPU drawer with handle -GN

Caddy mit Vertikalrollladen, 43 cm breit

Caddy with vertical roller blind, 43 cm wide

desk-add
05.01

Caddy mit Vertikalrollladen, 43 cm breit

caddy with vertical roller blind, 43 cm wide







43 cm breit / wide
45 cm tief / deep
113 cm hoch / high
inkl. Griff -GA / incl. handle -GA

Trägermaterial Abdeckplatte:
Oberfläche:
basic material for top:
surface:

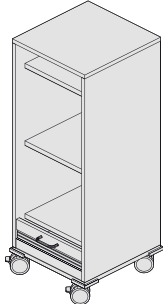
Spanplatte
Melamin
chipboard
melamine

Spanplatte
Echtholz
chipboard
real wood



Griff für
Rollladen
handle for
roller blind

			SM	SF	
 Rückseite rear side		mit drei Einlegeböden with 3 shelves DACV2-01- **			-GB -GF -GG -GI -GJ -GK -GN
		mit drei Einlegeböden und Materialdrehchale with 3 shelves and swivelling pencil tray DACV2-02- **			-GB -GF -GG -GI -GJ -GK -GN
		mit drei Einlegeböden, Materialdrehchale und Auszug für A4-Hängemappen with 3 shelves, swivelling pencil tray and A4 filing frame DACV2-03- **			-GB -GF -GG -GI -GJ -GK -GN
		mit zwei Einlegeböden und Breitschub with 2 shelves and organisation drawer DACV2-04- **			-GB -GF -GG -GI -GJ -GK -GN
		mit zwei Einlegeböden, Breitschub und Auszug für A4-Hängemappen with 2 shelves, organisation drawer and A4 filing frame DACV2-05- **			-GB -GF -GG -GI -GJ -GK -GN
Notwendige Farbangaben: Necessary colour details:		1. Korpus / carcass	2. Abdeckplatte / top		

Griffe siehe 01.01 / types of handles see 01.01

Caddy-Einteilungen zur nachträglichen Montage

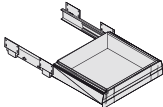
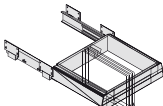
interior accessories for later assembly







	Breitschub (es entfällt 1 Einlegeboden) organisation drawer (1 shelf is left off)	DAC-BS1	179,--
	pro Caddy ist nur 1 Hängerahmen möglich! only 1 filing frame possible for each caddy!	Auszug für A4-Hängemappen A4 filing frame	DAC-HR1 171,--
	Materialdrehchale swivelling pencil tray	DAC-MD1	41,--

Farbangaben siehe Kapitel 01 / colour details see chapter 01

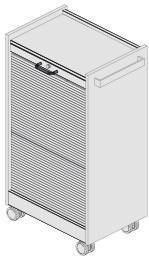

Caddy mit Vertikalrollladen, 60 cm breit

Caddy with vertical roller blind, 60 cm wide

desk-add
05.02

Caddy mit Vertikalrollladen, 60 cm breit		caddy with vertical roller blind, 60 cm wide				
60 cm breit / wide 43 cm tief / deep 110 cm hoch / high inkl. Griff -GA / incl. handle -GA		Trägermaterial Seitenteile: Oberfläche: basic material for side parts surface:	Spanplatte Melamin chipboard melamine	Spanplatte Echtholz chipboard real wood	Griff für Rollladen handle for roller blind	Für -SM: Seitenteile in 070, 071 For -SM: side parts in 070, 071
			SM	SF		
	 <p>mit drei Einlegeböden with 3 shelves</p>	DACV3-01- **			-GB -GG -GK -GN -GM	-FO1
	 <p>mit drei Einlegeböden und MaterialdrehSchale with 3 shelves and swivelling pencil tray</p>	DACV3-02- **			-GB -GG -GK -GN -GM	-FO1
	 <p>mit drei Einlegeböden, MaterialdrehSchale und Auszug für A4-Hängemappen with 3 shelves, swivelling pencil tray and A4 filing frame</p>	DACV3-03- **			-GB -GG -GK -GN -GM	-FO1
	 <p>mit zwei Einlegeböden und Breitschub mit Materialschale with 2 shelves and organisation drawer</p>	DACV3-04- **			-GB -GG -GK -GN -GM	-FO1
	 <p>mit zwei Einlegeböden, Breitschub mit Materialschale und Auszug für A4-Hängemappen with 2 shelves, organisation drawer with pencil tray and A4 filing frame</p>	DACV3-05- **			-GB -GG -GK -GN -GM	-FO1
Notwendige Farbangaben: Necessary colour details:		1. Oberboden, Rückwand und Blende vorn top, back panel and front panel		2. Seitenteile / side parts 3. Rollladen / roller blind		2. Seitenteile side parts

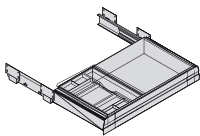
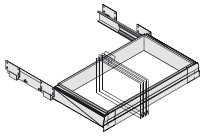
Griffe siehe 01.01 / types of handles see 01.01

Caddy-Einteilungen zur nachträglichen Montage		interior accessories for later assembly	
	Breitschub mit Materialschale (es entfällt 1 Einlegeboden) organisation drawer with pencil tray (1 shelf is left off)	DAC-BS2	221,--
	pro Caddy ist nur 1 Hängerahmen möglich! only 1 filing frame possible for each caddy!	Auszug für A4-Hängemappen A4 filing frame	DAC-HR2 179,--
	MaterialdrehSchale swivelling pencil tray	DAC-MD1	41,--

Caddy mit Horizontalrollladen, 80 cm breit

Caddy with horizontal roller blind, 80 cm wide

desk-add
06.01

Caddy mit Horizontalrollladen, 80 cm breit

caddy with horizontal roller blind, 80 cm wide







80 cm breit / wide
45 cm tief / deep
108 cm hoch / high
inkl. Griff -GA / incl. handle -GA

Trägermaterial Abdeckplatte:
Oberfläche:
basic material for top:
surface:

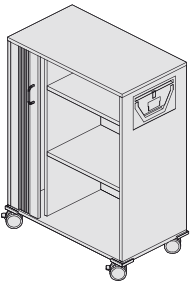
Spanplatte
Melamin
chipboard
melamine

Spanplatte
Echtholz
chipboard
real wood

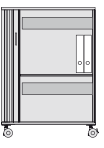
Griff für
Rollladen
handle for
roller blind

			SM	SF	
	 <p>mit zwei Einlegeböden with 2 shelves</p>	DACH2-01- **			-GB -GF -GG -GI -GJ -GK -GN
	 <p>mit zwei Einlegeböden und Materialdrehchale with 2 shelves and swivelling pencil tray</p>	DACH2-02- **			-GB -GF -GG -GI -GJ -GK -GN
	 <p>mit einem Einlegeboden und Breitschub mit Materialschale with 1 shelf and organisation drawer with pencil tray</p>	DACH2-03- **			-GB -GF -GG -GI -GJ -GK -GN
	 <p>mit einem Einlegeboden, Breitschub mit Materialschale und Auszug für A4-Hängemappen with 1 shelf, organisation drawer with pencil tray and A4 filing frame</p>	DACH2-04- **			-GB -GF -GG -GI -GJ -GK -GN
	 <p>mit zwei Einlegeböden und Auszug für A4-Hängemappen with 2 shelves and A4 filing frame</p>	DACH2-05- **			-GB -GF -GG -GI -GJ -GK -GN
<p>Notwendige Farbangaben: Necessary colour details:</p>		1. Korpus / carcass	2. Abdeckplatte / top		

Griffe siehe 01.01 / types of handles see 01.01

Caddy-Einteilungen zur nachträglichen Montage

interior accessories for later assembly

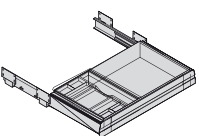
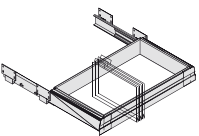
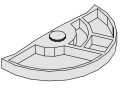
	<p>Breitschub mit Materialschale (es entfällt 1 Einlegeboden) organisation drawer with pencil tray (1 shelf is left off)</p>	DAC-BS2	221,--	
	<p>pro Caddy ist nur 1 Hängerahmen möglich! only 1 filing frame possible for each caddy!</p>	<p>Auszug für A4-Hängemappen A4 filing frame</p>	DAC-HR2	179,--
	<p>Materialdrehchale swivelling pencil tray</p>	DAC-MD1	41,--	

Farbangaben siehe Kapitel 01 / colour details see chapter 01

Caddy mit grifflosen Blenden, 43,5 cm breit

Caddy, blinds without handles, 43,5 cm wide

desk-add
07.01

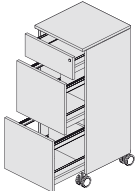
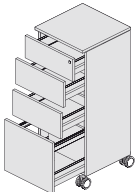
Caddy mit grifflosen Blenden, 43,5 cm breit		caddy, blinds without handles, 43,5 cm wide			
43,5 cm breit / wide 43,5 cm tief / deep 103 cm hoch / high	Trägermaterial Abdeckplatte und Blenden: Oberfläche:	Spanplatte Melamin	Spanplatte Echtholz	Compactplatte Melamin	Für -SM: Abdeckpl./Blenden in 070, 071 For -SM: top/blinds in 070, 071
	basic material blinds and top: surface:	chipboard melamine	chipboard real wood	scl melamine	
		SM	SF	CM	
	1 Organisationsschubfach, 2 Fächer mit Hängerahmen f. A4-Hängemappen DACS1-01- ** 1 drawer, 2 drawers with A4 filing frame				-FO1
	3 Organisationsschubfächer, 1 Fach mit Hängerahmen für A4-Hängemappen DACS1-02- ** 3 drawers, 1 drawer with A4 filing frame				-FO1
Notwendige Farbangaben: Necessary colour details:	1. Korpus / carcass	2. Abdeckplatte und Blenden / top and blinds		2. Abdeckplatte und Blenden top and blinds	

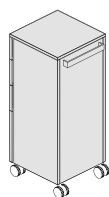

Rückseite
rear side

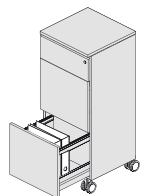

- Schubfächer bis max. 12 kg belastbar
- **im Fach mit Hängerahmen können auch Ordner untergebracht werden**
- load bearing capacity for each drawer max. 12 kg
- **ring binders can also be stored in drawers with A4 filing frames**

Aufbauprinzip

basic structure

Apothekerschrank, 72 cm hoch, Ausführung links
pull-out cupboard unit, 72 cm high, left version

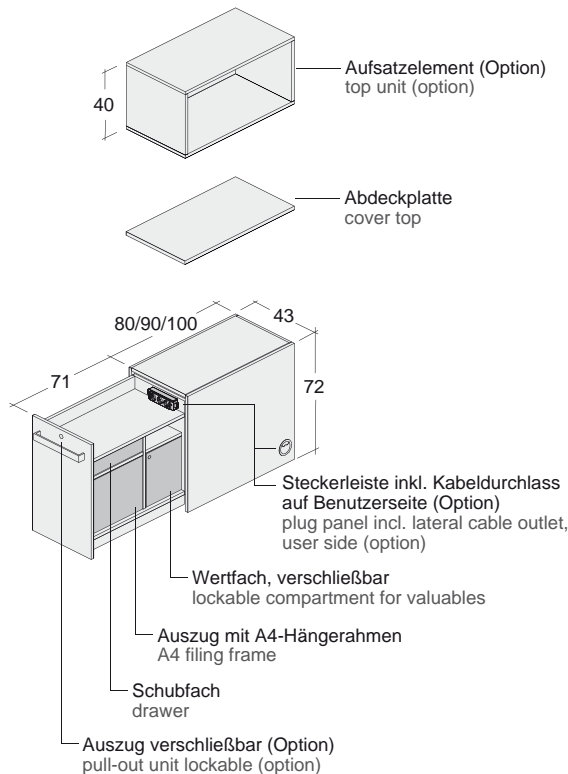

lichte Maße in cm
inner dimensions in cm

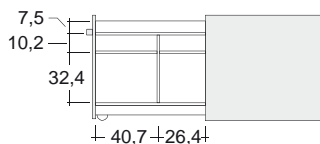

Apothekerschrank, 120 cm hoch, Ausführung links
pull-out cupboard unit, 120 cm high, left version

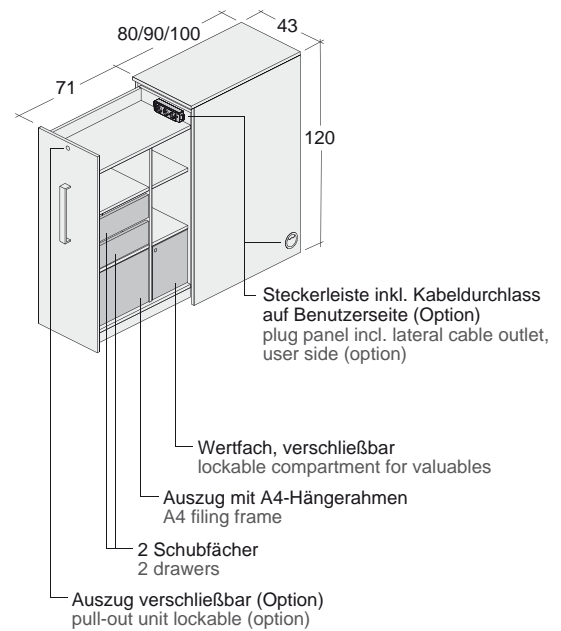

lichte Maße in cm
inner dimensions in cm

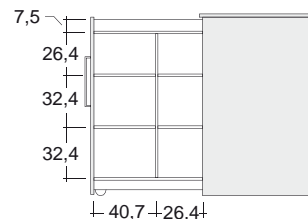

Übersicht Varianten der Abdeckplatten für Apothekerschranke

survey of the top variants for pull-out cupboard units

-O (Höhe 72 cm / height 72 cm)
Variante für Aufsatzelement (Option -AE), ohne Abdeckplatte
variant for top unit (option -AE), without cover plate

-A (Höhe 120 cm / height 120 cm)
Spanplatte, 19 mm chipboard, 19 mm
Oberfläche: melaminharzbeschichtet surface: melamine
Farbe: 011, 014, 024, 026, 041, 042, 049 colour: 011, 014, 024, 026, 041, 042, 049
051, 052, 072, 080, 081, 082 051, 052, 072, 080, 081, 082

-P (Höhe 72 cm / height 72 cm) (GO², TUNE, TUNE⁰)
Compactplatte, 13 mm solid core laminate (scl), 13 mm
Oberfläche: melaminharzbeschichtet surface: melamine
Farbe: 041, 049 (Kante schwarz) colour: 041, 049 (edge black)

-B (Höhe 120 cm / height 120 cm)
Spanplatte, 19 mm chipboard, 19 mm
Oberfläche: echtholz furniert surface: real wood veneer
Farbe: 111, 122, 131, 132, 141, 161, 171, colour: 111, 122, 131, 132, 141, 161, 171, 181, 191 181, 191

-Q (Höhe 72 cm / height 72 cm) (TUNE, TUNE⁰)
Spanplatte, 16 mm chipboard, 16 mm
Oberfläche: melaminharzbeschichtet surface: melamine
Farbe: 011, 014, 024, 026, 041, 042, 049 colour: 011, 014, 024, 026, 041, 042, 049
051, 052, 072, 080, 081, 082 051, 052, 072, 080, 081, 082

-F (Höhe 72 cm / height 72 cm) (GO², SPINE², iMOVE⁰)
Spanplatte, 22 mm chipboard, 22 mm
Oberfläche: melaminharzbeschichtet surface: melamine
Farbe: 011, 014, 024, 026, 041, 042, 049 colour: 011, 014, 024, 026, 041, 042, 049
051, 052, 072, 080, 081, 082 051, 052, 072, 080, 081, 082

-R (Höhe 72 cm / height 72 cm) (TUNE, TUNE⁰)
Spanplatte, 16 mm chipboard, 16 mm
Oberfläche: echtholz furniert surface: real wood veneer
Farbe: 111, 122, 131, 132, 141, 161, 171, colour: 111, 122, 131, 132, 141, 161, 171, 181, 191 181, 191

-M (Höhe 72 cm / height 72 cm) (GO², SPINE², iMOVE⁰)
Spanplatte, 22 mm chipboard, 22 mm
Oberfläche: echtholz furniert surface: real wood veneer
Farbe: 111, 122, 131, 132, 141, 161, 171, colour: 111, 122, 131, 132, 141, 161, 171, 181, 191 181, 191

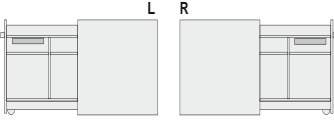
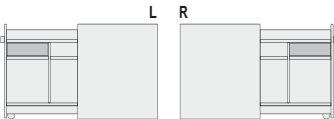
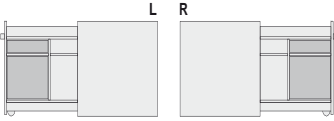
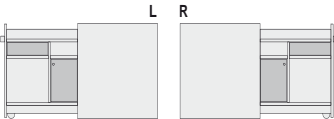
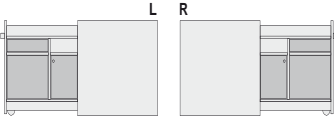
Apothekerschrank, 72 cm hoch		pull-out cupboard unit, 72 cm high								
Aufbauprinzip und Varianten der Abdeckplatten siehe 08.01! basic structure and survey of top variants see 08.01!		Tiefe / depth	Abdeckplatte	08 80 cm tief / deep		09 90 cm tief / deep		10 100 cm tief / deep		
				Front Melamin front melamine	Front Echtholz front real wood	Front Melamin front melamine	Front Echtholz front real wood	Front Melamin front melamine	Front Echtholz front real wood	
Inneneinrichtung / interior equipment				SM	SF	SM	SF	SM	SF	
Anstellseite links (L), rechts (R) / left version (L), right version (R)										
 <p>mit Materialdreh- schale with swiv. pencil tray</p>	DAAS * -01 -** /07 -O -**									
	DAAS * -01 -** /07 -P -**									
	DAAS * -01 -** /07 -Q -**									
	DAAS * -01 -** /07 -R -**									
	DAAS * -01 -** /07 -F -**									
	DAAS * -01 -** /07 -M -**									
 <p>mit Schubfach with drawer</p>	DAAS * -02 -** /07 -O -**									
	DAAS * -02 -** /07 -P -**									
	DAAS * -02 -** /07 -Q -**									
	DAAS * -02 -** /07 -R -**									
	DAAS * -02 -** /07 -F -**									
	DAAS * -02 -** /07 -M -**									
 <p>mit Schubfach und A4-Hangerahmen with drawer and A4 filing frame</p>	DAAS * -03 -** /07 -O -**									
	DAAS * -03 -** /07 -P -**									
	DAAS * -03 -** /07 -Q -**									
	DAAS * -03 -** /07 -R -**									
	DAAS * -03 -** /07 -F -**									
	DAAS * -03 -** /07 -M -**									
 <p>mit Schubfach und Wertfach with drawer and comp. for valuables</p>	DAAS * -04 -** /07 -O -**									
	DAAS * -04 -** /07 -P -**									
	DAAS * -04 -** /07 -Q -**									
	DAAS * -04 -** /07 -R -**									
	DAAS * -04 -** /07 -F -**									
	DAAS * -04 -** /07 -M -**									
 <p>mit Schubfach, Wertf. und A4-Hangerahmen with drawer, A4 filing frame and comp. for valuables</p>	DAAS * -05 -** /07 -O -**									
	DAAS * -05 -** /07 -P -**									
	DAAS * -05 -** /07 -Q -**									
	DAAS * -05 -** /07 -R -**									
	DAAS * -05 -** /07 -F -**									
	DAAS * -05 -** /07 -M -**									
Notwendige Farbangaben: Necessary colour details:	1. Korpus / carcass	cover top	2. Abdeckplatte / cover top						3. Front / front	

Optionen			options		
Option	Beschreibung	description	Korpustiefe / depth of carcass		
			80 cm	90 cm	100 cm
-AE	Aufsatzelement (Korpus ohne Abdeckplatte, Variante -O)	top unit (carcass without cover plate, variant -O)			
Notwendige Farbangabe: / Necessary colour detail:			1. Korpus / carcass		
-VS	verschiebar	lockable			
-SL	3fach Steckerleiste mit Netzanschlusskabel 5 m, Kabeldurchlass auf Benutzerseite	3way plug panel with mains connection cable 5 m, incl. lateral cable outlet, user side			
-KD	zusatztlicher Kabeldurchlass gegenuber Benutzerseite	additional cable outlet, opposite side			
Notwendige Farbangabe: / Necessary colour detail:			4. Kabeldurchlass / cable outlet		

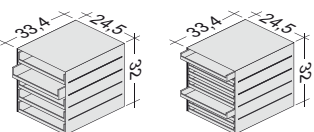
Zubehor		accessories	
	Kunststoff-Ablageset, Einheit mit 5 Schalen plastic filing set, unit with 5 trays	DA-ZKAS05	
	Kunststoff-Ablageset, Einheit mit 10 Schalen plastic filing set, unit with 10 trays	DA-ZKAS10	

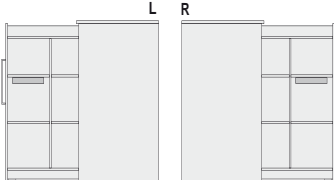
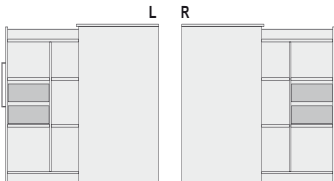
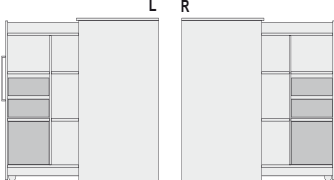
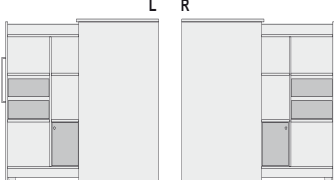
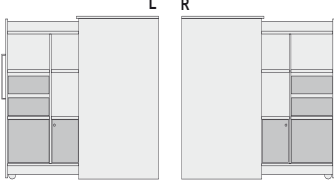
Apothekerschrank, 120 cm hoch		pull-out cupboard unit, 120 cm high							
Aufbauprinzip und Varianten der Abdeckplatten siehe 08.01! basic structure and survey of top variants see 08.01!		Tiefe / depth	Abdeckplatte	08 80 cm tief / deep		09 90 cm tief / deep		10 100 cm tief / deep	
				Front Melamin front melamine	Front Echtholz front real wood	Front Melamin front melamine	Front Echtholz front real wood	Front Melamin front melamine	Front Echtholz front real wood
Inneneinrichtung / interior equipment				SM	SF	SM	SF	SM	SF
Anstellseite links (L), rechts (R) / left version (L), right version (R)									
 <p>mit MaterialdrehSchale with swiv. pencil tray</p>	L	R	DAAS * -01 -** /12 -A -**						
			DAAS * -01 -** /12 -B -**						
 <p>mit 2 Schubfächern with 2 drawers</p>	L	R	DAAS * -02 -** /12 -A -**						
			DAAS * -02 -** /12 -B -**						
 <p>mit 2 Schubfächern u. A4-Hängerahmen with 2 drawers and A4 filing frame</p>	L	R	DAAS * -03 -** /12 -A -**						
			DAAS * -03 -** /12 -B -**						
 <p>mit 2 Schubfächern und Wertfach with 2 drawers and comp. for valuables</p>	L	R	DAAS * -04 -** /12 -A -**						
			DAAS * -04 -** /12 -B -**						
 <p>mit 2 Schubfächern, A4-Hängerahmen und Wertfach with 2 drawers, A4 filing frame and comp. for valuables</p>	L	R	DAAS * -05 -** /12 -A -**						
			DAAS * -05 -** /12 -B -**						
Notwendige Farbangaben: Necessary colour details:		1. Korpus / carcass		cover top	2. Abdeckplatte / cover top				
					3. Front / front				

Optionen			options
Option	Beschreibung	description	
-VS	verschießbar	lockable	
-SL	3fach Steckerleiste mit Netzanschlusskabel 5 m, Kabeldurchlass auf Benutzerseite	3way plug panel with mains connection cable 5 m, incl. lateral cable outlet, user side	
-KD	zusätzlicher Kabeldurchlass gegenüber Benutzerseite	additional cable outlet, opposite side	
Notwendige Farbangabe: / Necessary colour detail:			4. Kabeldurchlass / cable outlet

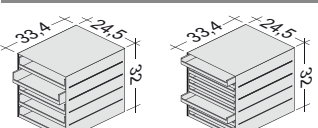
Zubehör		accessories
	Kunststoff-Ablageset, Einheit mit 5 Schalen plastic filing set, unit with 5 trays	DA-ZKAS05
	Kunststoff-Ablageset, Einheit mit 10 Schalen plastic filing set, unit with 10 trays	DA-ZKAS10

